



## SMART GRID DL SGWD2.0



### **WHY A SMART GRID?**

Since the early 21<sup>st</sup> century, technological development in power electronics, telecommunications and data processing techniques have converged to address the limitations and costs of management of the electrical grid. Technological limitations on metering no longer force peak power prices to be averaged out and passed on to all consumers equally. These improvements give more flexibility to optimize and adjust the energy production forecast dynamically according to the changes in demand based on real-time data.

Growing environmental concerns have led to the adoption of international agreements and engagements to reduce the environmental impact from fossil fuel-fired power stations. The need to provide cleaner energy has increased the participation of renewable energies in the mix. The dominant forms, wind and solar power, are highly variable by nature and require more sophisticated control systems to allow the connection of these alternative sources to the otherwise highly controllable grid. The rapidly falling costs of these technologies are driving a major shift in the grid architecture from a highly centralized topology with larger power plants, to a more distributed system, with power being both generated and consumed right at the limits of the grid.

Finally, growing concern over terrorist and cyber-attacks in some countries has revealed the need for a more robust energy grid that is less dependent on centralized power stations that are perceived to be potential attack targets.



## **WHAT IS A SMART GRID?**

The Smart Grid is a system for an "intelligent distribution" of electricity. It can monitor the consumption of the various end users to manage and adapt the generation and distribution of electricity according to demand. Simply put, if a given area has a potential overload of energy, the excess of energy can be redistributed to other areas that need it, based on the actual requests from end users.

The supervision software that runs the Smart Grid monitors and manages the electrical flow in the system. It can integrate renewable energy into the network and can activate, suspend, or shift the industrial and domestic processes to periods when electricity costs are more convenient.

The smart grid knows our power consumption requirement. When electricity demand is at its maximum, the smart grid automatically adapts by picking up excess energy from many sources to avoid overload problems or power interruptions. It has, therefore, the function of managing and sharing the electricity in a heterogeneous grid with distributed generation of electricity derived from various types of sources, both public and private, traditional and renewable, and ensures that electrical devices use electricity as efficiently as possible.



## KEY CHARACTERISTICS

### Modularity

- Scaled-down model of entire power distribution system
- Reconfigurable lab composed of discrete elements
- Industrial grade devices

### Open SCADA Web

- Software to supervise and control all the active components of the network
- Software-based learning platform structured using a didactic approach
- Open software platform for full customization

### Didactic approach

- Multidisciplinary laboratory that covers from the most basic concepts of electrical engineering to more advanced configurations
- Hands-on, experiment-based, training platform

### Skills development

- Students interact with real industrial equipment
- Platform for simulating real scenarios
- Development of analytical and troubleshooting skills



## DE LORENZO'S SOLUTION

De Lorenzo has designed a modular trainer that studies the power flow and interaction between the electricity supplier's networks (generation, transmission, and distribution systems) and the consumers (residential and/or commercial customers).

Industrial grade equipment has been integrated into a controlled environment, providing a flexible and reconfigurable learning platform to study electrical power engineering applications.

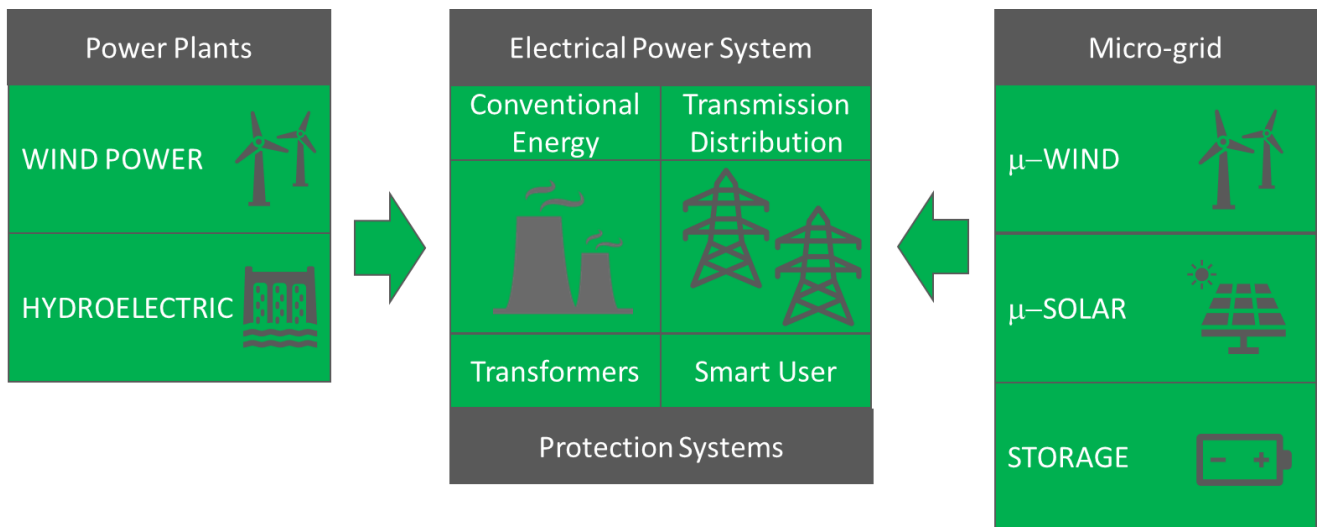

The core of the laboratory is a simplified scaled-down model of a power distribution system. Several power sources from different renewable energies are connected to the system on different points simulating a distributed power generation system. The energy can be added from the production side (high and mid voltage) or from the end-user side (microgrid).

The system includes 3 different energy generation subsystems:

- A variable pitch wind plant.
- A hydroelectric plant with pumped storage.
- Micro-grid energy sources using a solar photovoltaic system with battery storage and an optional micro-wind system generating energy from the low voltage side of the grid.

A double busbar system and circuit breakers allow the isolation of sections of the system or the insertion of the available renewable energy sources to create a bidirectional power flow in the distribution network.

A set of active measurement devices are strategically placed to monitor the power flow in the system in real time and provide protection. The operation of the laboratory is done through the SCADA software.

An industrial feeder manager relay can be configured to study the protection techniques at different points of the system.



# SMART GRID



## Transmission and distribution system:

At the core of the system, the Smart Grid laboratory includes all the modules to simulate a simplified distribution system with unidirectional power flow, transmitting energy from a conventional thermal plant to an end user.



A power supply connected to the mains represents a coal plant connected to the infinite bus.

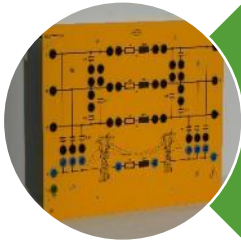

HV transmission lines of several lengths, busbar, and power switches simulate the power distribution and transmission system.



Dedicated measurement devices are distributed in key points of the system to monitor the power flow.



Industrial feeder manager relay provides protection to specific sections of the system.



# SMART GRID



## Energy use and consumption:

The end user represented by an RLC load and a load management system to simulate different consumption profiles.

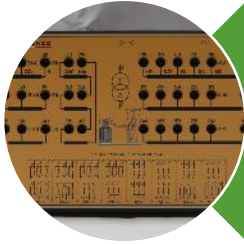

An isolation transformer acts as a step down transformer.



Automatic power factor compensator with capacitor banks.

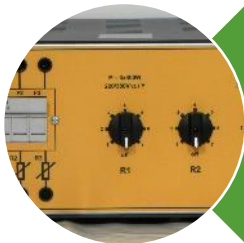

Variable resistive, inductive and capacitive loads simulate the end-users consumption.



Energy meter, load manager and HMI simulate different consumption profiles acting as a smart user that can regulate his consumption based on his requirements and the cost of energy.



## Hydro-electric system:

The hydroelectric plant is simulated by a three-phase synchronous machine that can be used to generate power or to simulate a pumped storage system to handle the excess of energy in the grid.

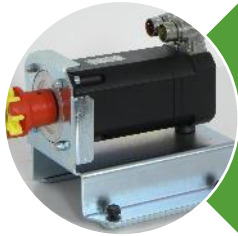

Brushless servo-motor that represents the pelton turbine of a hydro power plant.



Synchronous generator that transforms the mechanical power into electricity.

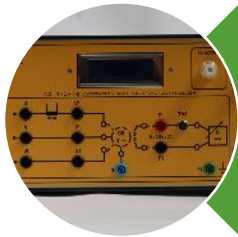

Excitation controller with droop  $V/Q$  function for closed loop regulation of the reactive power when connected to the grid.



Isolation transformer that acts as a step-up transformer.

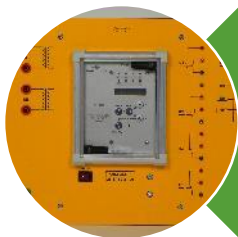

Synchronization relay to connect the generator to the grid.



# SMART GRID

## Wind power system:

A variable pitch wind plant is simulated with a three-phase asynchronous induction machine.



Brushless servo-motor that represents a wind turbine.



Asynchronous machine transforms the mechanical power into electricity.



Isolation transformer that acts as a step-up transformer.



Network power analyzer.





# SMART GRID

## Microgrid solar:

From the end user side, different power sources provide energy to the system.



Real solar photovoltaic panel illuminated with a halogen light source that simulates the sun.



Photovoltaic panel simulator: programmable DC power supply that behaves as a solar panel providing power to the single-phase grid tie inverter.



An inverter charger-module further expands the features of the solar system providing storage capabilities.

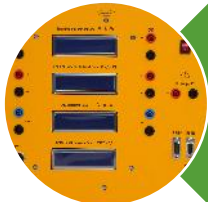

Dedicated instruments and load provide the information needed for the characterization of the solar panel and measure the flow of power to the system.



A programmable active DC load is used to characterize the solar panel.



## OPEN SCADA-WEB

The full system is integrated by an industrial Supervision and Control Data Acquisition (SCADA) software that communicates with all the active devices in the trainer and performs the following actions:

- acquisition and measurements of the physical quantities of the system;
- control of the system's operation;
- visual supervision of the system (also in remote mode), through the use of synoptic diagrams: operational status, alarms, etc.

Through the SCADA software, the operator can monitor the electric flow in the system to manage and optimize the power requirements based on the consumption, through the acquisition of real-time data from the measuring devices and protection relays and the control of actuators for an "intelligent" management of the whole electrical system.

The different sections of the trainer communicate through ethernet and dedicated serial RS485 buses using standard industrial communication protocols such as MODBUS RTU.

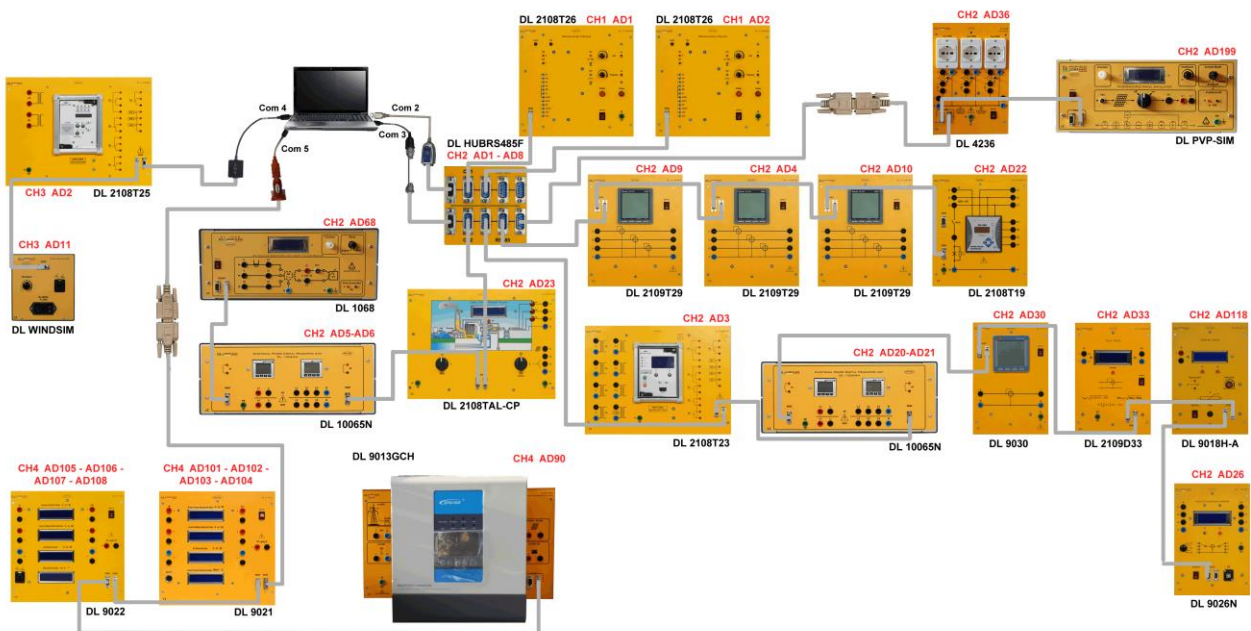

The SCADA project is divided in templates each one corresponding to a particular exercise. The open SCADA-WEB developers license provided with the trainer allows the teachers to fully customize the existing templates or create new ones that can be used to monitor the system from a local workstation.



# SMART GRID



## SCADA main features

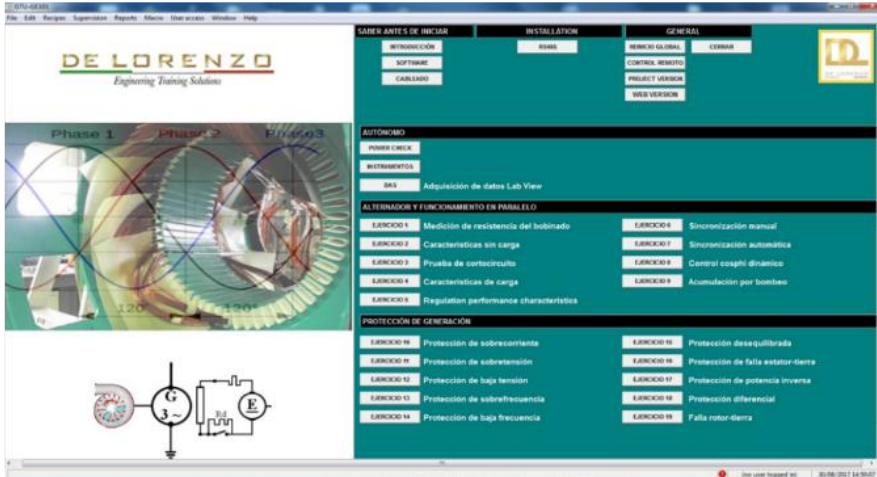

The software is structured following a didactic approach, dividing each study unit into single exercises.

The open SCADA-WEB license gives the teachers the possibility to create their own projects and fully customize the experiments by displaying the parameters of interest and controlling the actuators for an “intelligent” power management.

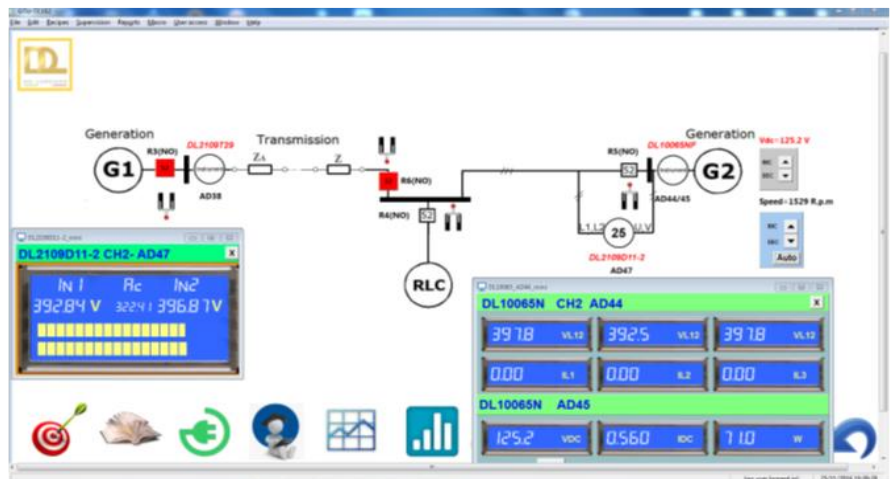

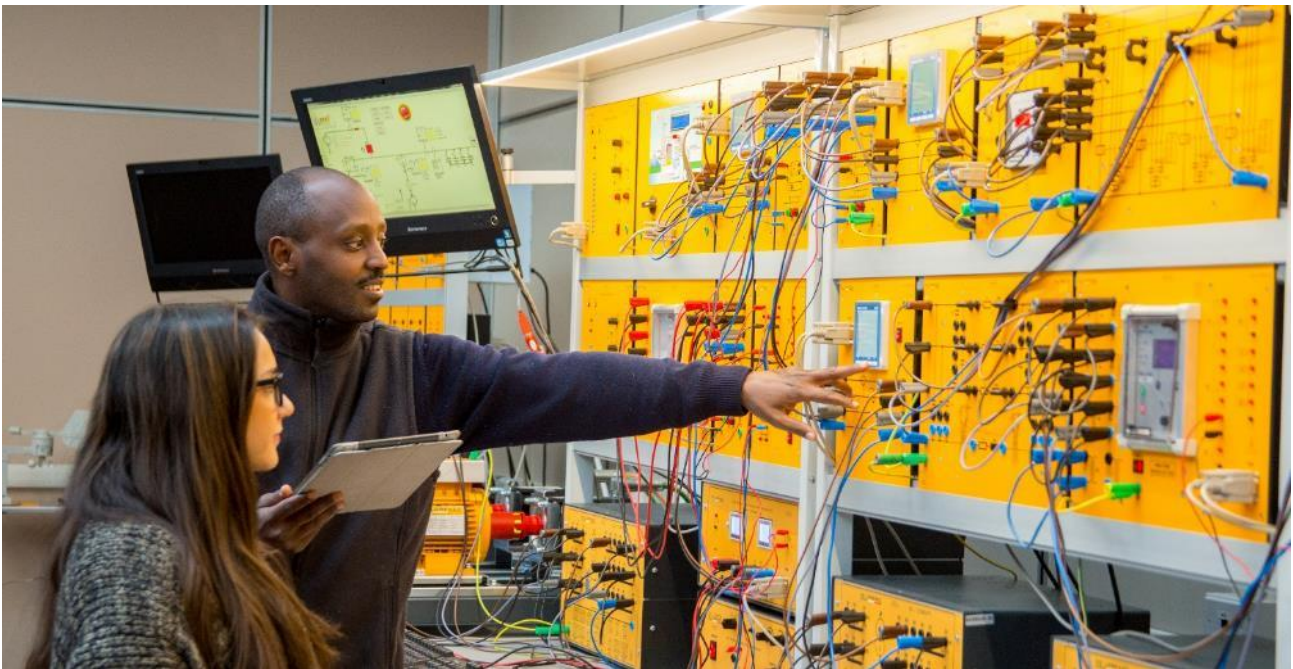

## **TRAINING OBJECTIVES**

The Smart Grid trainer is a multidisciplinary laboratory, aimed at undergraduate and graduate courses in the engineering schools for the study of energy management in a modern power grid. The laboratory equipment can be configured to create different exercises, which reinforce basic and advanced concepts in electric energy.

The smart grid system is an integrated laboratory that can be used by mechanical and electrical engineering students as a longtime project as it comprises enough elements to cover most of the topics such as electric circuits, electric machinery, hydroelectricity, renewable energies, power transmission, and power distribution. The main purpose is to study the principles of power engineering and study the power flow to develop advanced energy management strategies.

The entire system is fully configurable and can be tested under many conditions. Different experiments can be performed by rearranging the wiring and placement of the modules giving a lot of flexibility to simulate a full smart grid system with various network topologies. The proposed exercises in different topics connect theoretical and practical concepts through hands-on experience.

This innovative laboratory can include class demonstrations and laboratory experiments under regular laboratory classes. It provides a controlled and safe platform for further experimentation to simulate different network conditions and faults to study network efficiency, stability, and protection. The system architecture which uses standard industrial communication protocols and a fully customizable open SCADA software, makes it a complementary tool for research and development, further expanding its capabilities.



## Skills development:

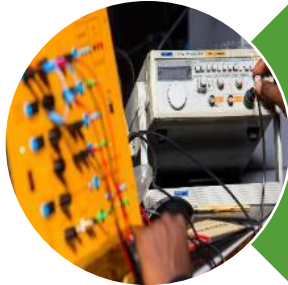

### Basic:

- Circuits theory: validate the basic electric laws and circuit theory using three-phase power.
- Electrical measurements: Use of industrial measurement devices and protection relays.
- Renewable energies: photovoltaic energy, Wind energy.



### Intermediate:

- Electric machines: study of a three-phase transformer and alternator or a motor acting as load.
- Power electrical engineering: generation, transmission, distribution and use of electrical power.
- Power electronics, control systems, digital control, embedded systems.
- Energy Storage



### Advanced:

- Grid: Study of different network topologies.
- Energy management: Power flow control, fault simulation and troubleshooting.
- Power system stability, droop control.
- Intelligent power systems "Smart Grid".
- Energy cost and optimization methods.
- Stochastic processes, prediction, and data analytics.



## LIST OF EXPERIMENTS

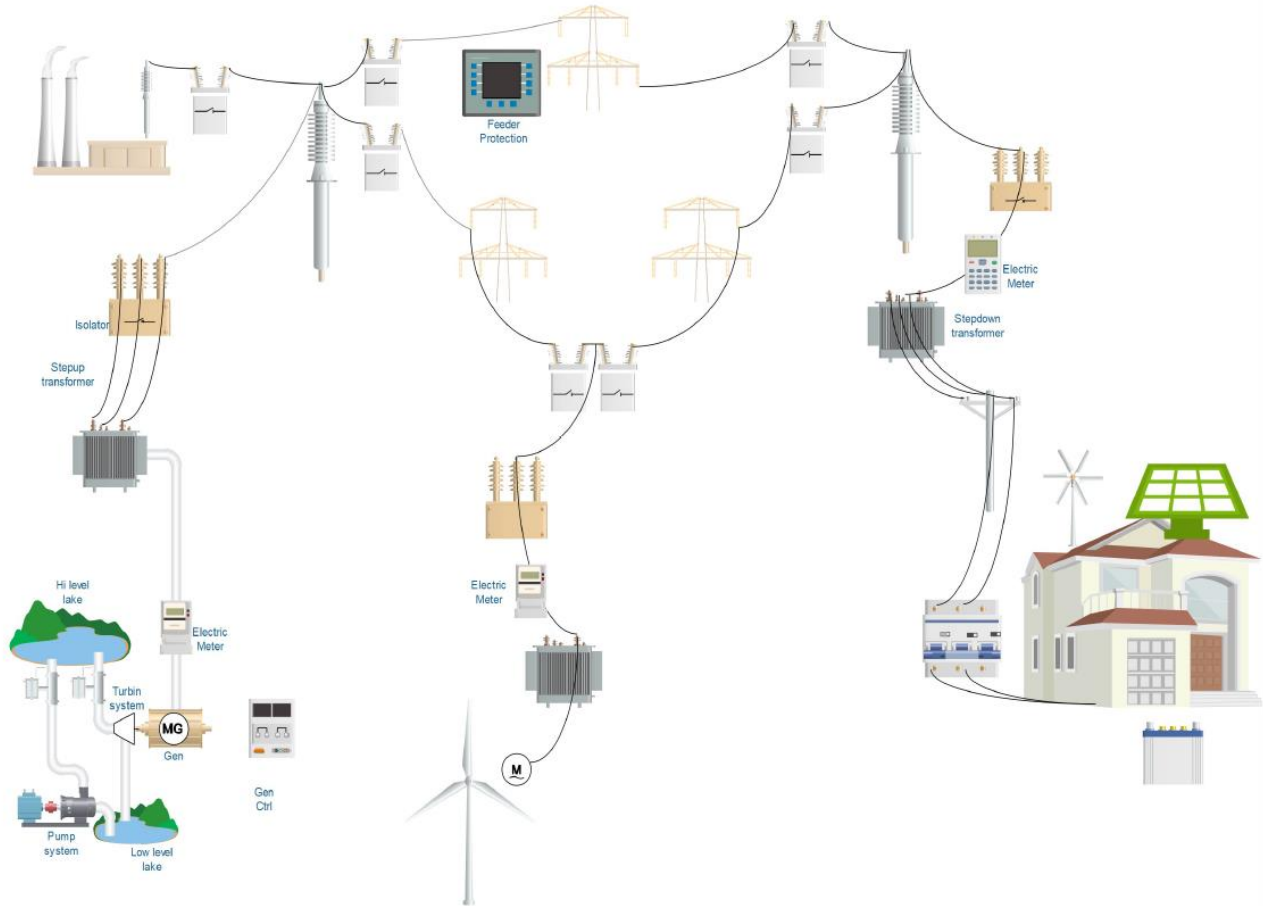

### LOAD ANALYSIS

- R, L, C load characteristics
- Active energy measurement
- Reactive energy measurement
- Manual power factor compensation
- Automatic power factor compensation

### HYDROELECTRICAL SYSTEM

- Generator no-load characteristic
- Generator load characteristic
- Regulation performances characteristics
- Automatic synchronization
- Reactive power regulation (Droop V/Q)
- Pumped storage
- Overcurrent protection
- Over-voltage and under-voltage protection
- Over-frequency or under-frequency protection



## **WIND SYSTEM**

The relation between a pitch control system and wind  
Analysis of the mechanical parameters within an induction generator  
Analysis of electrical parameters within an induction generator

## **MICROGRID SYSTEM**

Characterization of a photovoltaic panel without a load  
Characterization of a photovoltaic panel with a load  
Connecting a photovoltaic system to the real network by using an inverter grid system single-phase.  
Solar power battery storage

## **TRANSFORMER**

Vector group  
No-load performance  
Load performance  
Asymmetrical performance  
Regulation performance

## **TRANSMISSION**

No-load performances  
Matched-load performances  
Ohmic-inductive load  
Ohmic-capacitive load  
Radial network  
Meshed network  
Transmission line earth-fault  
Transmission line symmetrical short circuit  
Transmission line asymmetrical short circuit  
Transmission line earth-fault protection  
Transmission line instant and definite time overcurrent protection  
Transmission line under-voltage protection

## **DISTRIBUTION:**

Basic double busbar system  
Double busbar system with load  
Busbar coupling

## **SMART GRID**

Contribution of microgrid energy  
Contribution of hydropower  
Contribution of wind plant



## LIST OF MODULES

DL 2108T26	Brushless Controller With Motor	2
DL 2108T26BR	Braking resistance	1
DL 1021/4	Squirrel cage three phase asynchronous motor	1
DL 1013A	Base	2
DL 1026P4	Three-Phase Synchronous Machine	1
DL 1017R	Resistive Load	1
DL 1017L	Inductive Load	1
DL 1017C	Capacitive Load	1
DL 2108TAL-CP	Three Phase Supply Unit	1
DL 1068	AC Machine excitation and droop V-Q controller	1
DL 7901TT	Overhead Line Model – 360 Km	2
DL 7901TTS	Overhead Line Model – 110 Km	1
DL 2109T29	Three-Phase Power Meter	5
DL 2108T25	Generator Synchronizing Relay	1
DL 2108T23	Feeder Manager Relay	1
DL 2108T02	Power Circuit Breaker	3
DL 2108T02A	Power Circuit Breaker	1
DL 2108T02/2	Double busbar	3
DL 2108T19	Reactive Power Controller	1
DL 2108T20	Switchable Capacitor Battery	1
DL 2108T20C	Rephasing capacitor module for induction machine	1
DL 4236	Load manager	1
DL HMI	Human machine interface	1
DL 2109T34	Three-phase active and reactive energy meter	1
DL 9013G	Inverter Grid	1
DL 9013G1C	Single phase inverter charger	1
BAT100AGM	12V - 100Ah Battery	1
PFS-85	Photovoltaic Solar Panel	1
DL SIMSUN	Lamps For The Photovoltaic Solar Panel	1
DL 9021	Measurement module for photovoltaic panels	1
DL 9018H-A	DC Active load	1
DL 2101T13-DC	Transformer with rectifier	1
DL PVP-SIM	Photovoltaic panel simulator	1
DL HUBRS485F	Modbus Communication Hub	1
DL SCADA3+	Software Scada	1
DL 1080TT	Three-Phase Transformer	3
DL 1155SGWD	Kit Of Connecting Leads	1
DL T12090	120x90 Working Bench	3
DL T06090	60x90 Working Bench	3
DL A120-3M-LED	Frame	3
DL PCGRID	All-In-One Personal Computer	1
DL 2100TTI	Three-Phase Transformer	1
DL 1196	Holder For Leads	1





## Options:

- **Microgrid wind energy:** It allows adding a microgrid wind energy system in parallel to the photovoltaic solar system at the user end of the system – **ordering code: DL SGWD2.0-W.**



A micro-grid wind turbine powered by a servo-motor simulating the action of the wind.

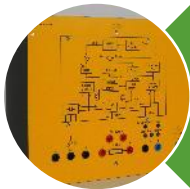

A single phase grid-tie inverter that feeds power from the turbine into the mains



Dedicated instrument provide the information needed for the characterization of the wind system.

## Modules:

DL T12090	120x90 Working Bench	1
DL A120-3M-LED	Frame	1
DL 9027	Three-phase active and reactive energy meter	1
DL WTS-CTRL750	Control module for brushless motor 750W	1
DL WTS-3	Wind Turbine Simulator	1
DL 9013G3D	Inverter grid module 300W IN 3ph. 12Vac with braking resistance	1